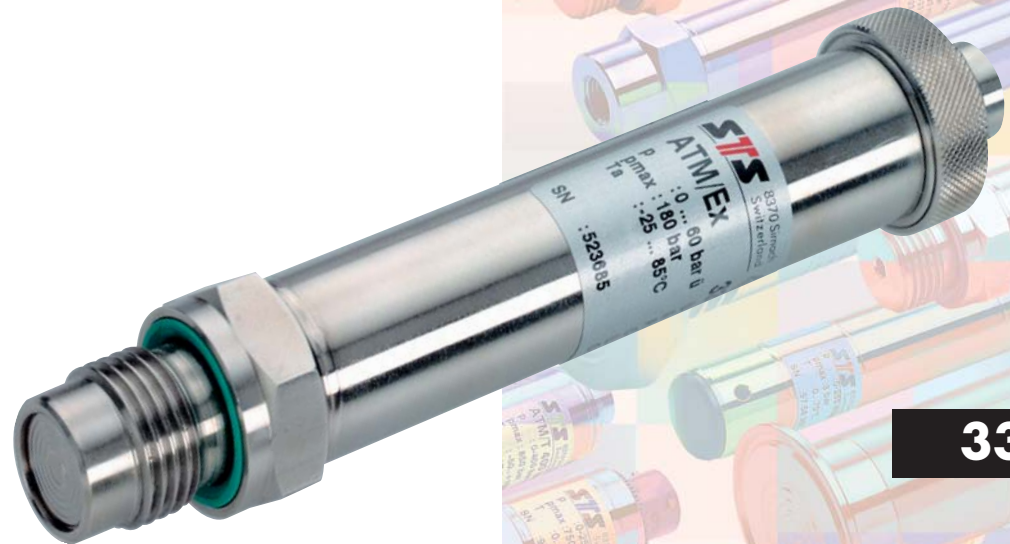

INTRINSICALLY SAFE PRESSURE TRANSMITTER ATM/Ex

**33**

Features

- Compact and robust stainless steel assembly 1.4435 (316L)
- Piezoresistive measuring element
- Standard DIN pressure ranges from 0...100mbar to 0...1000bar
- Calibration available for all common pressure units
- Reverse polarity and short circuit protected
- Medium temperature up to 150°C (option)
- Surge (lightning) protection according to EN 61000-4-5 (option)

Typical applications

- In hazardous areas
- Industrial process control
- Mining
- Food industry
- Test and Monitoring

Hyxo Oy

P.O. Box 16 (Palokorvenkatu 2)
FI-04261 Kerava, Finland
Tel. +358 10 417 4500
Fax +358 10 417 4501
hyxo@hyxo.fi • www.hyxo.com

STS - feel the Difference

Specifications

Pressure range	[bar]	0.1 ... 0.5	> 0.5 ... 2	> 2 ... 25	> 25 ... 600	> 600 ... 1000
Overpressure		3bar	3 x FS (min. 3 bar)	3 x FS	3 x FS (max. 850bar, optional 1500bar)	1500 bar
Burst pressure	[bar]	> 200	> 200	> 200	> 850 (optional 1500bar)	1500
Accuracy¹⁾	[± % FS]	≤ 0.5 (optional ≤ 0.25)	≤ 0.5 (optional ≤ 0.25/≤ 0.1)	≤ 0.5 (optional ≤ 0.25/≤ 0.1)	≤ 0.5 (optional ≤ 0.25/≤ 0.1)	≤ 1 (optional ≤ 0.5/≤ 0.25)
Thermal shift	[± % FS/°C]					
Zero	0...70°C	≤ 0.06	≤ 0.03	≤ 0.015	≤ 0.015	≤ 0.015
	-25...85°C	≤ 0.08	≤ 0.04	≤ 0.02	≤ 0.02	≤ 0.02
Span	0...70°C	≤ 0.015	≤ 0.015	≤ 0.015	≤ 0.015	≤ 0.015
	-25...85°C	≤ 0.02	≤ 0.02	≤ 0.02	≤ 0.02	≤ 0.02
Response time		< 1 ms/10...90% FS				
Long term stability (1 year) - (typ./max.)		<0.5% FS/< 4mbar	<0.2% FS/< 4mbar	<0.1% FS/< 0.2% FS	<0.1% FS/< 0.2% FS	<0.1% FS/< 0.2% FS

¹⁾ Zero based non-conformity according to DIN 16086, including hysteresis and repeatability

Electrical connection

Type	4...20mA Two wire current transmitter	
Supply voltage	10...30V DC	
Supply voltage influence	< 0.1% FS	
Load resistance		
Circuit diagram		Load resistance influence < 0.1% FS

Ex-Approval

Type of protection Certificate	SEE 99 ATEX 2640	I/II M1/1G EEx IIC T3...T6 II 1D T90°C IP68	Ex-Approval for gas and mines Ex-Approval for dust special requirements in mines general requirements intrinsic safety "i" special requirements zone 0 zener barrier
Standards		EN 50303 EN 50 014 EN 50 020 EN 50 284	
Max. values for supply/output circuit		30V / 100mA / 1W	
Temperature class		T6	T4
Ambient temperature T _a	[°C]	-25...55	-25...85
Process temperature	[°C]	-25...55	-25...100
			T3
			-25...85
			-25...150

Without any information about temperature class the transmitter will be delivered for gas.

³⁾ Only use DIN-Connector in gas group IIB, In Zone 0 only cable output permitted

Materials

Process connection, diaphragm, housing	Stainless steel 1.4435 (316L), other materials (e.g. titanium) on request
Seals (standard)	Viton (other materials see ordering information)

Electromagnetic compatibility

Standard	Level	Typical interferences	
Emission:			
EN 61000-6-3	Generic emission standard		
EN 55022	Emission, class B		
Immunity:			
EN 61000-6-2	Generic immunity		
EN 61000-4-2	Electrostatic discharge	4kV contact, 8kV air	
EN 61000-4-3	Radiated electro-magnetic field	10V/m, 80-1000MHz, 80% AM 1kHz	Cellular phones, radio sets
EN 61000-4-3	Radiated electro-magnetic field (GSM)	10V/m, 950MHz, 200Hz on/off	Digital portable phones
EN 61000-4-4	Fast transients (burst)	2kV	Motors, valves
EN 61000-4-6	Conducted radio-frequency	10V, 0.15-80MHz, 80% AM 1kHz	Cellular phones, radio sets
EN 61000-4-5	Surge	10kA (8/20μs) ²⁾	Lightning strikes

²⁾ Only with optional surge (lightning) protection



Ordering Information

33 X . XXXX . XXXX . XX . XXX

Type	ATM/Ex	33				
Pressure type	Gauge	1				
	Absolute	2				
	Sealed gauge	3				
Pressure range	0...100mbar		00			
	0...160mbar		01			
	0...250mbar		02			
	0...400mbar		03			
	0...600mbar		04			
	0...1.0bar		05			
	0...1.6bar		06			
	0...2.5bar		07			
	0...4.0bar		08			
	0...6.0bar		09			
	0...10bar		10			
	0...16bar		11			
	0...25bar		12			
	0...40bar		3	13		
	0...60bar		3	14		
	0...100bar		3	15		
	0...160bar		3	16		
	0...250bar		3	17		
	0...400bar		3	18		
	0...600bar		3	19		
0...1000bar		3	20			
Special calibration			99			
Process connection	G 1/4 female (Fig. 1)			00		
	G 1/4 M (Fig. 2)			11		
	G 1/4 M, Manometer DIN 16288 (Fig. 3)			12		
	G 1/2 M (Fig. 4)			13		
	G 1/2 M, frontal diaphragm (Fig. 5)			14		
	G 1/2 M, flush diaphragm (Fig. 6)			15		
	G 1/2 M, Manometer DIN 16288 (Fig. 7)			16		
	1/4 NPT M			10		
	1/2 NPT M (Fig. 8)			19		
	Special process connection			99		
Electrical connection	Connector DIN 43650 (screwed on ³⁾) ⁵⁾ (Fig. 10)	IP 65			01	
	Connector Binder 723, 5-pin ⁵⁾ (Fig. 11)	IP 67			03	
	Connector Binder 723, 5-pin (screwed on ³⁾) ⁵⁾ (Fig. 12)	IP 67			43	
	Connector MIL C26482, (10-6) ⁵⁾ (Fig. 13)	IP 40			06	
	PUR cable, blue ⁶⁾ (Fig. 14)	IP 67			17	
	Teflon cable, blue ⁶⁾ (Fig. 14)	IP 67			22	
	Special electrical connection				99	
Output signal	4...20mA				05	
	4...20mA surge (lightning) protection				08	
Accuracy	≤ ± 0.5% FS				0	
	≤ ± 0.25% FS				1	
	≤ ± 0.1% FS (on request)				2	
Temperature class	T6 (Ta: -25...55°C comp.)				0	
	T4 (Ta: -25...85°C comp.)				1	
	T3 (Ta: -25...85°C comp., max. medium temp. 150°C)				2	
Options	Throttle ⁴⁾					A
	Special oil filling in the TD: ASEOL Food					G
	Halocarbon					H
	Seals: Viton (standard)					U
	EPDM					S
	Kalrez					T
	Special options					Z
Version titanium					K	

³⁾ Zero offset and span adjustable (approx. ± 5%)

⁶⁾ Please specify the required cable length

⁴⁾ Available only with fig. 2, fig. 4 or fig. 7

⁵⁾ Cable socket connector not included

Pressure Connection

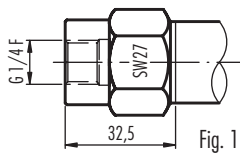

Fig. 1

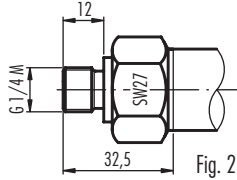

Fig. 2

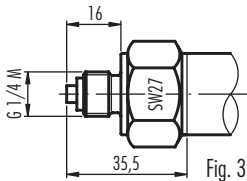

Fig. 3

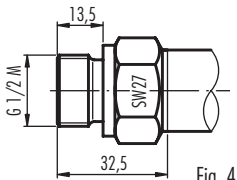

Fig. 4

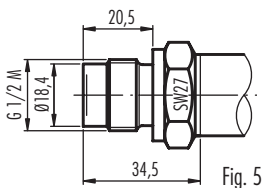

Fig. 5

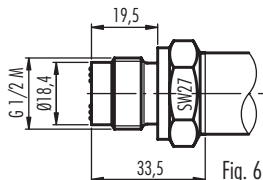

Fig. 6

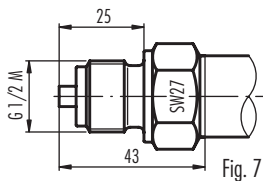

Fig. 7

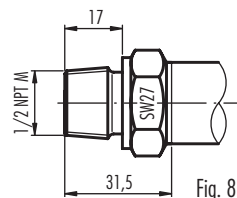
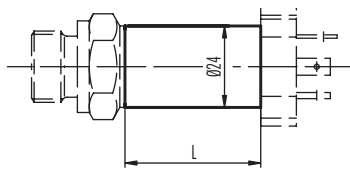

Fig. 8

Dimensions

Version for temperature class T4...T6



L = 55mm for connector DIN 43650 (Fig. 10)
L = 94mm for version with surge (lightning) protection

Version for temperature class T3

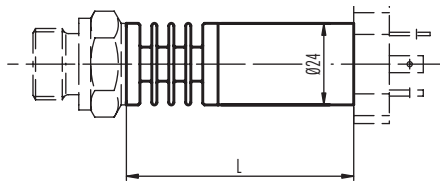

L = 82mm for connector DIN 43650 (Fig. 10)
L = 121mm for version with surge (lightning) protection

Electrical Connection

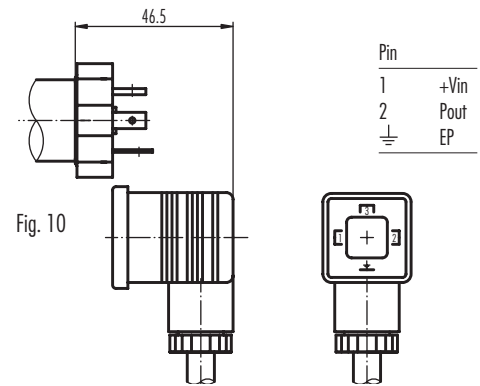

Fig. 10

Pin	
1	+Vin
2	Pout
⊥	EP

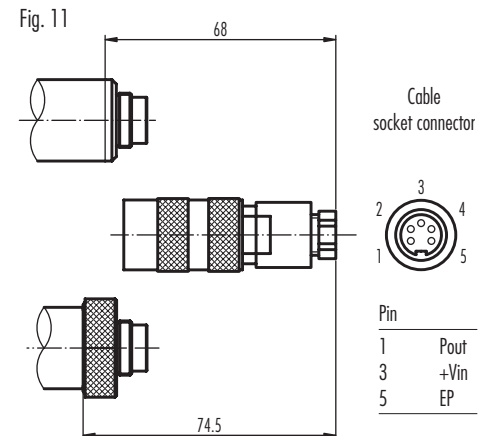

Fig. 11

Pin	
1	Pout
3	+Vin
5	EP

Fig. 12

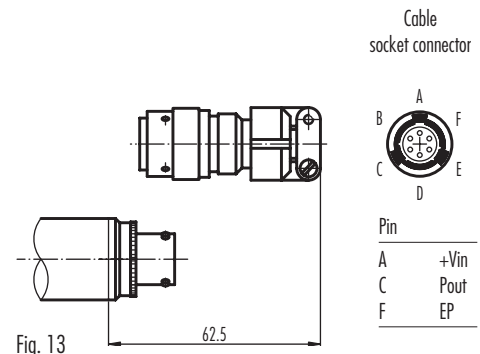

Fig. 13

Pin	
A	+Vin
C	Pout
F	EP

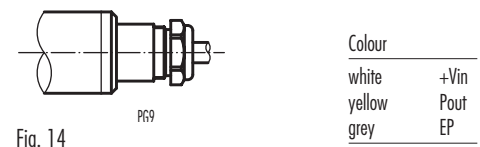

Fig. 14

Colour	
white	+Vin
yellow	Pout
grey	EP

Specifications may change without notice.

Switzerland

STS Sensor Technik Sirmach AG
Rüthhofstrasse 8
CH - 8370 Sirmach
Tel.: +41 (0)71 969 49 29
Fax: +41 (0)71 969 49 20
e-mail: sales@sts-ag.ch
Internet: www.sts-ag.ch

Germany

STS Sensoren Transmitter Systeme GmbH
Mercedesstrasse 1
D - 71063 Sindelfingen
Tel.: +49 (0)7031 811 920
Fax: +49 (0)7031 811 958
e-mail: sts.gmbh@t-online.de
Internet: www.sts-ag.ch

Italy

STS Italia s.r.l.
Via Gesù 5
I - 20090 Opera (MI)
Tel.: +39 02 57607073/074
Fax: +39 02 57607110
e-mail: stsopera@tin.it
Internet: www.sts-ag.ch

DED019B Release 12/2003

France

STS France
66, Avenue de la Gare
FR - 74100 Annemasse
Tel.: +33 (0)4 5037 6925
Fax: +33 (0)4 5039 4225
e-mail: info@stsfrence.fr
Internet: www.sts-ag.ch